

Front

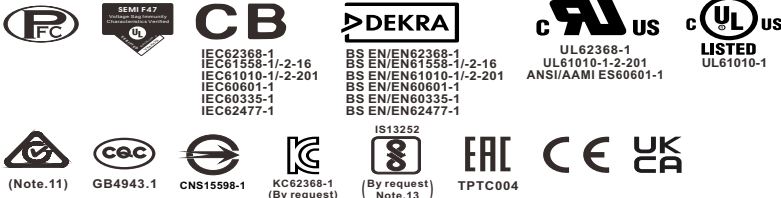

Back



Features

- 85~305Vac input with PFC(277Vac available)
- Global certificates in multi-fields (ITE 62368-1, Medical 60601-1, Household 60335-1, Industrial 61558-1/2-16/61010-1/2-201, Energy converter 62477-1), SEMI F47 at 200Vac
- 200% peak power capability
- High efficiency up to 93%
- Output voltage 0~120% and output current 0~100% programmable
- Current sharing up to 9600W(3+1) for parallel use
- Built in ORing MOS By request, Order NO. : NSP-2400-xxOR/MODOR
- CANBus(Built in) or MODBus protocol (By request)
- -40~85°C wide range operation temperature(> +60°C derating)
- Extremely low leakage current<500uA, 2 x MOPP, suitable for BF medical applications
- Built-in constant current limiting circuit
- Protections: Short circuit / Overload / Over voltage / Over temperature
- Built-in remote ON/OFF control/Remote Sense/ DC OK signal
- Auxiliary 5Vdc and 12Vdc
- Over voltage category III (OVC III)
- Operating altitude up to 5000 meters
- Built-in intelligent fan speed control, low noise <46dB
- Conformal coating
- 5 years warranty

Applications

- Industrial automation machinery/ control system
- Security system
- Mechanical and electrical equipment
- Electronic instruments, equipments or apparatus
- Network equipment
- Telecom devices
- Power sourcing equipment of PoE
- Home automation
- Medical devices
- Supercapacitor

GTIN CODE

MW Search: <https://www.meanwell.com/serviceGTIN.aspx>

Description

The NSP-2400 series is a 2400W AC/DC power supply with PFC function, designed for high reliability and suitable for multiple industries. Key features include: compact size (325.8*107*41mm) for better space utilization in system installations, ultra-wide input range of 85~305Vac for global compatibility, up to 93% efficiency, programmable output voltage (0~120%) and current (0~100%), constant current design with 200% peak power capability, parallel output capacity up to 9600W, built-in CANBus communication interface, wide operating temperature range from -40 to +85°C (+60°C at full load), compliance with OVCIII, built-in Remote Control /Remote Sense/DC OK signal/auxiliary power, internal PCB coating, complete protections, certifications for multiple safety standards including 62368-1, 60601-1, 61558-1, 60335-1, 62477-1, and 61010-1, as well as 2 X MOPP compliance and extremely low leakage current (<500µA). It is suitable for BF-rated medical equipment and comes with a 5-years warranty, making it a highly cost-effective solution for industrial power supply needs.

Model Encoding

NSP - 2400 - 48 MOD

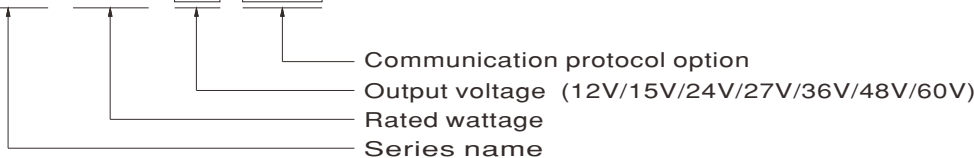

Type	Communication Protocol	Note
Blank	CANBus protocol	In Stock
MOD	MODBus protocol	By request

SPECIFICATION		NSP-2400-12	NSP-2400-15	NSP-2400-24	NSP-2400-27	NSP-2400-36	NSP-2400-48	NSP-2400-60	
		□ =Blank (standard model in stock), MOD (By request model)							
OUTPUT									
DC VOLTAGE		12V	15V	24V	27V	36V	48V	60V	
CURRENT		183.3A	146.7A	100A	88.8A	66.6A	50A	40A	
CURRENT RANGE		0 ~ 183.3A	0 ~ 146.7A	0 ~ 100A	0 ~ 88.8A	0 ~ 66.6A	0 ~ 50A	0 ~ 40A	
RATED POWER		2200W	2200W	2400W	2397W	2397W	2400W	2400W	
PEAK	Note.2	CURRENT	366.6A	293.3A	200A	177.6A	133A	100A	80A
		POWER	4400W	4400W	4800W	4795W	4795W	4800W	4800W
RIPPLE & NOISE (max.)	Note.3	300mVp-p	300mVp-p	300mVp-p	300mVp-p	350mVp-p	450mVp-p	600mVp-p	
VOLTAGE ADJ. RANGE		10.8 ~ 14.4V	13.5 ~ 19V	21.6 ~ 28.8V	24.3 ~ 32.4V	32.4 ~ 43.2V	43.2 ~ 55V	54 ~ 72V	
VOLTAGE TOLERANCE	Note.4	± 1.0%							
LINE REGULATION		± 0.5%							
LOAD REGULATION		± 0.5%							
SETUP, RISE TIME	Note.5	1800ms, 60ms/115Vac; 1800ms, 60ms/230Vac; 1800ms, 60ms/277Vac at full load							
HOLD UP TIME (Typ.)		12ms @ 70% load, 8ms @full load							
INPUT									
VOLTAGE RANGE	Note.6	85 ~ 305Vac	250 ~ 431Vdc						
FREQUENCY RANGE		47 ~ 63Hz							
POWER FACTOR (Typ.)		0.98/115Vac 0.95/230Vac 0.93/277Vac at full load							
EFFICIENCY (Typ.)		89%	90%	91%	91%	91.5%	92%	93%	
AC CURRENT (Typ.)		17A/115Vac	13A/230Vac	11A/277Vac					
INRUSH CURRENT (Typ.)		COLD START	30A/115Vac	60A/230Vac	75A/277Vac				
LEAKAGE CURRENT		Earth leakage current <500µA(rms)@277Vac ; Touch current<100µA(rms) @ 277Vac							
PROTECTION									
SHORT CIRCUIT	Note.7	PEAK POWER MODE	Constant current limiting, unit will shut down after 5 Sec, AC repower on to recover. (2 Sec for 12V/15V models)						
		CURRENT LIMITING MODE	Constant current limiting, recovers automatically after abnormal condition is removed						
OVERLOAD	Note.8	PEAK POWER MODE	From 105% to 200% of rated output power, unit will shut down after 5 seconds of continuous operation. AC repower on to recover. (2 Sec for 12V/15V models)						
			At >200% of rated output power, constant current limiting is activated. Unit will shut down after 5 seconds of continuous operation. AC repower on to recover. (2 Sec for 12V/15V models)						
		CURRENT LIMITING MODE	Constant current limiting, recovers automatically after abnormal condition is removed						
OVER VOLTAGE		15 ~ 19V	20 ~ 25V	29 ~ 37V	33 ~ 42V	44 ~ 54V	56 ~ 60V	73 ~ 86V	
		Protection type : Shut down and latch off output voltage, re-power on to recover							
OVER TEMPERATURE		Shut down output voltage, recovers automatically after temperature goes down							
FUNCTION									
OUTPUT CURRENT PROGRAMMABLE(PC)		Adjustment of constant current level is allowable between 0 ~ 100% of rated current. Please refer to the User Manual.							
OUTPUT VOLTAGE PROGRAMMABLE(PV)	Note.9	Adjustment of output voltage is allowable to 0 ~ 120% of nominal output voltage. Please refer to the User Manual.							
PARALLEL		Up to 9600W or (3+1) units. Please refer to the User Manual.							
AUXILIARY POWER		5Vaux @ 0.2A Tolerance ± 15%, ripple 150mVp-p							
		12Vaux @ 0.8A Tolerance ± 15%, ripple 450mVp-p							
REMOTE CONTROL		By electrical signal or dry contact Power ON: RC short Power OFF: RC open							
REMOTE SENSE		Compensate voltage drop on the load wiring up to 0.5Vdc							
DC OK SIGNAL		Contact rating(max.):5Vdc/10mA resistive load							
CANBus(BUILT-IN) or MODBus(By Request) INTERFACE		Communication provides functions such as control, setting and monitoring							
FAN NOISE (Typ.)	Note.10	Built-in intelligent fan speed control detect by PSU'S internal temperature							
		10% load with Ta=25℃	38dB						
		70% load with Ta=25℃	46dB	44dB	44dB	42dB	38dB	40dB	41dB
ENVIRONMENT									
WORKING TEMP.		-40 ~ +85℃ (Refer to "Derating Curve")							
WORKING HUMIDITY		20 ~ 90% RH non-condensing							
STORAGE TEMP., HUMIDITY		-40 ~ +85℃, 10 ~ 95% RH non-condensing							
TEMP. COEFFICIENT		± 0.03%/℃ (0 ~ 60℃)							
VIBRATION		10 ~ 500Hz, 2G 10min./1cycle, 60min. each along X, Y, Z axes							

SAFETY & EMC(Note 11~13)					
SAFETY STANDARDS	CB	IEC62368-1, IEC60335-1, IEC61558-1/-2-16, IEC61010-1/-2-201, IEC60601-1; IEC62477-1			
	DEKRA	BS EN/EN62368-1, BS EN/EN60335-1, BS EN/EN61558-1/-2-16, BS EN/EN61010-1/-2-201, BS EN/EN60601-1(3.2 Version);BS EN/EN62477-1			
	UL	UL62368-1, ANSI/AAMI ES60601-1(3.2 Version),UL61010-1/-2-201			
	CQC	GB4943.1			
	BSMI	CNS15598-1			
	EAC	TP TC 004			
	SEMI F47	approved			
	KC/BIS	KC 62368-1 and BIS IS 13252(Part 1) certified, No stock, contact sales by request			
ISOLATION LEVEL	Note.14	Primary-Secondary: 2xMOPP, Primary-Earth: 1xMOPP, Secondary-Earth: 1xMOPP			
OVER VOLTAGE CATEGORY	Note.15	IEC/EN 61558-1/-2-16	(OVC III, altitude up to 2000M)		
		IEC/EN/UL 62368-1	(OVC II, altitude up to 5000M)		
		IEC/EN 60335-1	(OVC II, altitude up to 5000M)		
		IEC/EN/ANSI/AAMI ES60601-1	(OVC II, altitude up to 4000M)		
		IEC/EN/UL 61010-1/-2-201	(OVC II, altitude up to 5000M)		
		IEC/EN 62477-1	(OVC II, altitude up to 5000M)		
SAFETY EXTRA-LOW VOLTAGE(SELV)		IEC/EN 61558-2-16 (SELV, 12 ~ 60V) IEC/EN 60335-1 (SELV, 12 ~ 36V) IEC/EN/UL 62368-1 (SELV/ES1, 12 ~ 48V)			
WITHSTAND VOLTAGE		I/P-O/P:4KVac I/P-FG:2KVac O/P-FG:1.5KVac			
ISOLATION RESISTANCE		I/P-O/P, I/P-FG, O/P-FG:100M Ohms / 500VDC / 25°C / 70% RH			
EMC EMISSION		Parameter	Standard	Test Level / Note	
		Conducted	BS EN/EN55032(CISPR32),CNS 15936,GB/T 9254.1,KS C 9832		Class B
			BS EN/EN55014-1(CISPR14-1)		
			BS EN/EN55011(CISPR11)		Class B
		Radiated	BS EN/EN55032(CISPR32),CNS 15936,GB/T 9254.1,KS C 9832		Class B
			BS EN/EN55014-1(CISPR14-1)		
			BS EN/EN55011(CISPR11)		Class B
Harmonic Current	BS EN/EN61000-3-2(IEC61000-3-2),GB 17625.1		Class A		
Voltage Flicker	BS EN/EN61000-3-3(IEC61000-3-3)		-----		
EMC IMMUNITY		BS EN/EN55035(CISPR35),BS EN/EN61000-6-2(IEC61000-6-2),BS EN/EN60601-1-2(IEC60601-1-2), BS EN/EN55014-2(CISPR14-2),KS C 9835,SEMI F47 tested at 200Vac			
		Parameter	Standard	Test Level / Note	
		ESD	BS EN/EN61000-4-2	Level 4, 15KV air ; Level 4, 8KV contact	
		Radiated	BS EN/EN61000-4-3	Level 3, 10V/m(80MHz~2.7GHz) Table 9, 9~28V/m(385MHz~5.78GHz)	
		EFT / Burst	BS EN/EN61000-4-4	Level 3, 2KV	
		Surge	BS EN/EN61000-4-5	Level 4, 2KV/Line-Line 4KV/Line-Earth	
		Conducted	BS EN/EN61000-4-6	Level 3, 10V	
		Magnetic Field	BS EN/EN61000-4-8	Level 4, 30A/m	
Voltage Dips and Interruptions	BS EN/EN61000-4-11	>95% dip 0.5 periods, 30% dip 25 periods, >95% interruptions 250 periods			
OTHERS					
MTBF	566.1K hrs min. Telcordia SR-332 (Bellcore) ; 47.3K hrs min. MIL-HDBK-217F (25°C)				
DIMENSION (L*W*H)	325.8*107*41mm				
PACKING	2.32Kg;4pcs/10.3Kg/1.09CUFT				
NOTE					
<ol style="list-style-type: none"> All parameters NOT specially mentioned are measured at 230Vac input, rated load and 25°C of ambient temperature. The peak power duration is 2 seconds for 12V/15V models and 5 seconds for all other models. Ripple & noise are measured at 20MHz of bandwidth by using a 12" twisted pair-wire terminated with a 0.1uF & 47uF parallel capacitor. Tolerance: includes set up tolerance, line regulation and load regulation. Setup time is measured at the first cold start. Derating may be required at low input voltages; refer to the "Static Characteristics" section for details. Operation under stabilized output voltage may trigger protective shutdown. For details on the overload protection mode, refer to the "Overload Protection Mode" section in the User Manual. When the output voltage is adjusted via the PV function, the output ripple and noise may exceed the specified limits under certain operating conditions. Fan noise measurement is performed in accordance with ISO 7779. The Regulatory Compliance Mark (RCM) is applied on a voluntary basis. The equipment meets the relevant IEC or AS/NZS standards, or AS/NZS 3820 where applicable. The use of the RCM mark complies with AS/NZS 4417.1. The power supply is considered a component which will be installed into a final equipment. All the EMC tests are been executed by mounting the unit on a 360mm*360mm metal plate with 1mm of thickness. The final equipment must be re-confirmed that it still meets EMC directives. For guidance on how to perform these EMC tests, please refer to "EMI testing of component power supplies." (as available on https://www.meanwell.com/Upload/PDF/EMI_statement_en.pdf) The BIS marking may not be available for certain manufacturing sites or models. Please contact your MEAN WELL sales rep for further information. MOPP is suitable for 100-240Vac input only. The ambient temperature derating of 3.5°C/1000m with fanless models and 5°C/1000m with fan models for operating altitude higher than 2000m(6500ft). 					
* Product Liability Disclaimer : For detailed information, please refer to https://www.meanwell.com/serviceDisclaimer.aspx					

Block Diagram

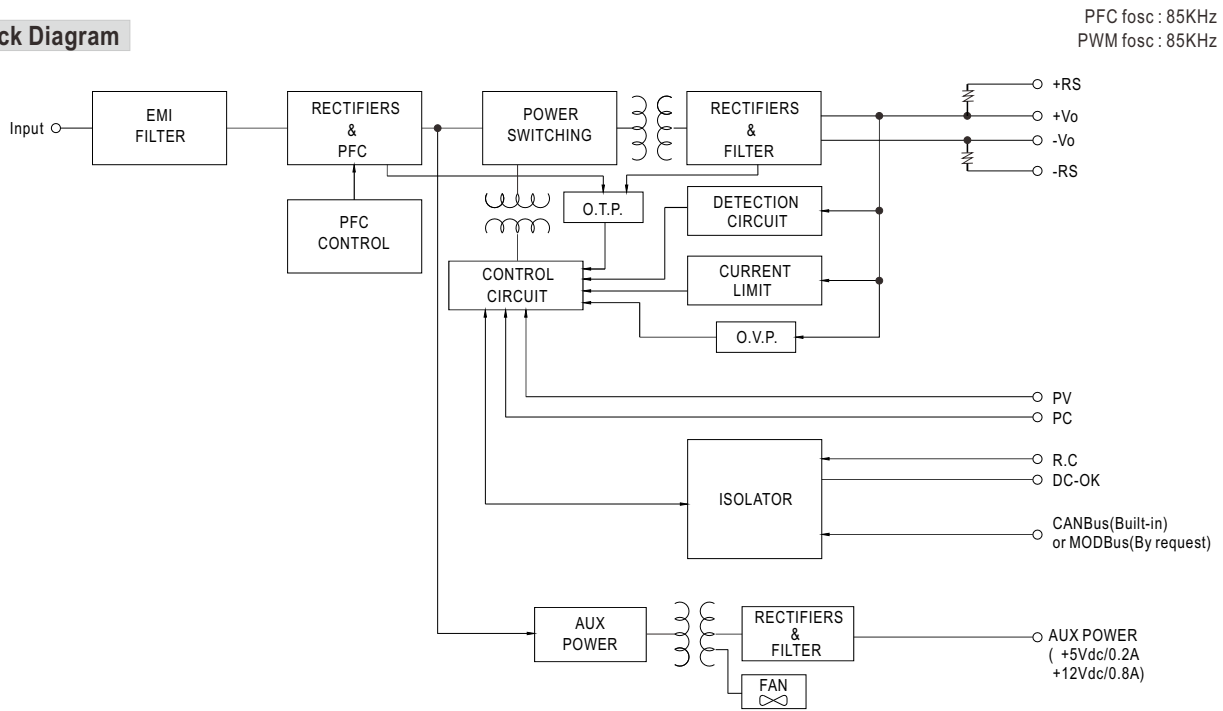

Derating Curve

◎ 12V/15V

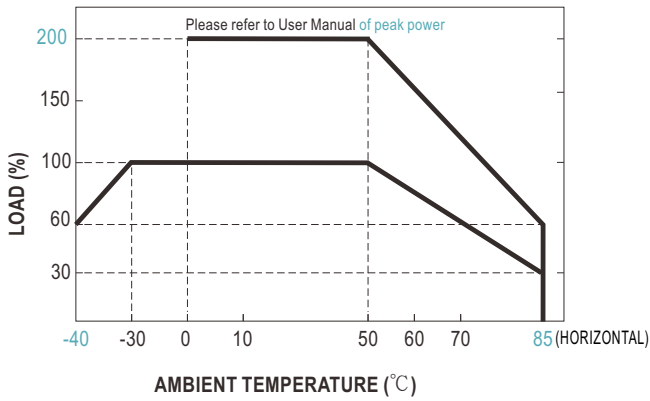

◎ Others

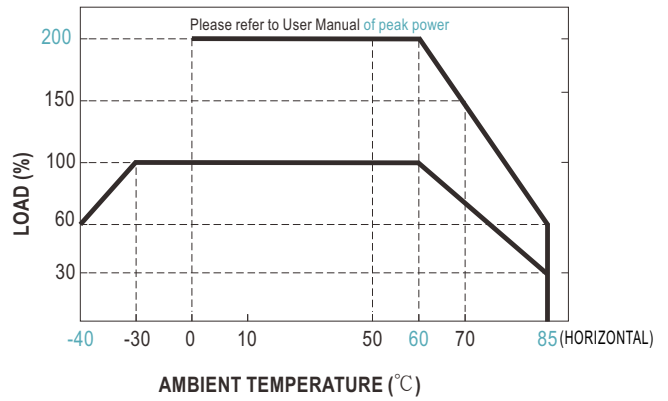

Static Characteristics

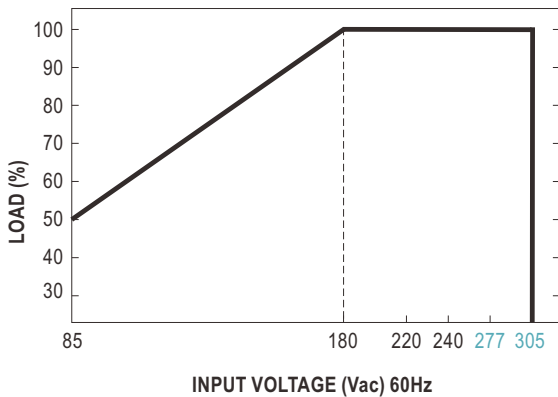

Efficiency vs Load (48V Model)

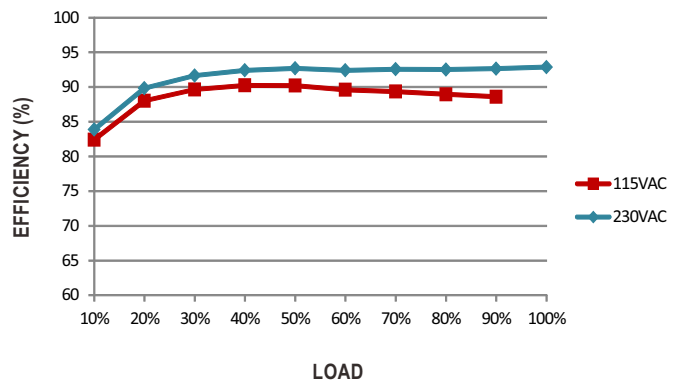

◎ The curve above is measured at 115/230Vac.

User Manual

1. Peak Power

$$P_{av} = \frac{P_{pk} \times t + P_{npk} \times (T-t)}{T} \leq P_{rated}$$

$$Duty = \frac{t}{T} \times 100\% \leq 35\%$$

$$t \leq 5 \text{ sec}$$

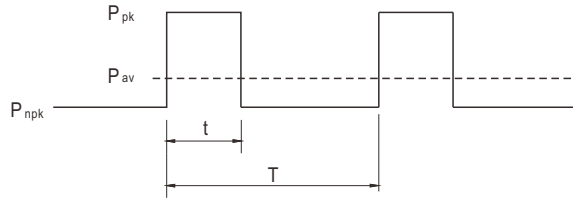

P_{av} : Average output power(W)

P_{pk} : Peak output power(W)

P_{nPk} : Non-peak output power(W)

P_{rated} : Rated output power(W)

t : Peak power width(sec)

T : Period(sec)

Note:

For 12V/15V models, $t \leq 2 \text{ sec}$.

For other models, $t \leq 5 \text{ sec}$.

12V/15V

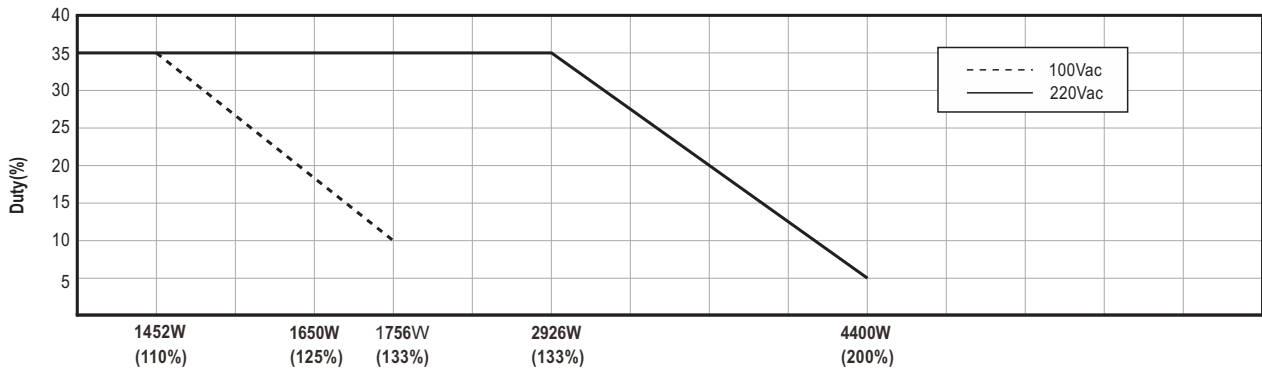

Others

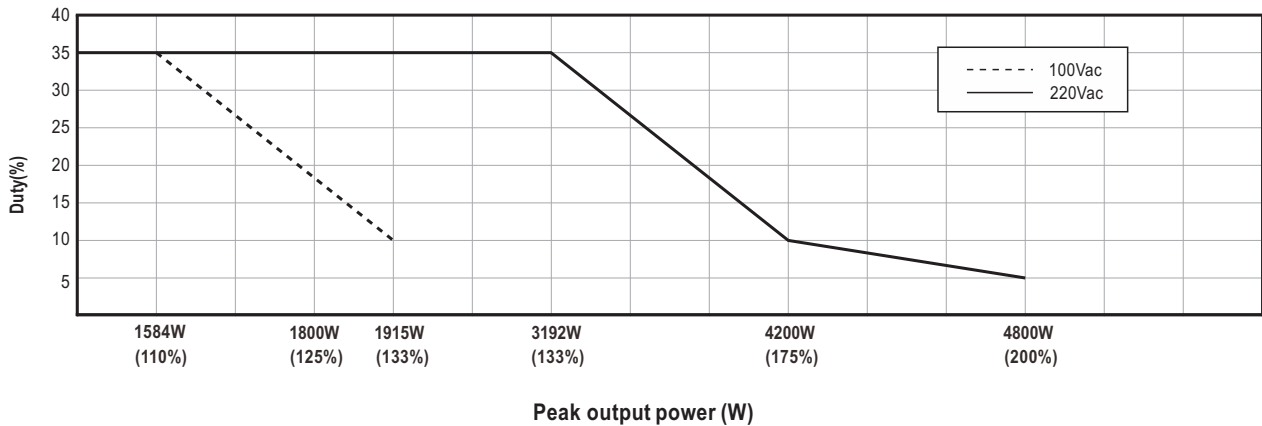

For example (24V model)

$V_{in}=220Vac$, Duty_max=5%

$P_{av}=P_{rated}=2400W$

$P_{pk}=4800W$

$t \leq 5sec$

$$T \geq \frac{5sec}{5\%} = 100sec$$

$$P_{nPk} \leq \frac{T \times P_{av} - t \times P_{pk}}{T-t} = 2273.8W$$

	12V/15V	Others
P_{pk}	4400W	4800W
P_{av}	1980W	2400W
Duty_max	5%	5%
t	$t \leq 2$	$t \leq 5$
T	$T \geq \frac{2sec}{5\%} = 40sec$	$T \geq \frac{5sec}{5\%} = 100sec$
$P_{nPk} \leq \frac{T \times P_{av} - t \times P_{pk}}{T-t}$	1853W	2274W

Note:

Input $\geq 220 \text{ Vac}$: Peak power = 2 × rated power

Input $< 220 \text{ Vac}$: Peak power = 1.33 × rated power

For 12V and 15V models, the average output power is limited to 90% of the rated output power.

2. Output Voltage Programming (P.V)

(1) Default by potentiometer (SVR)

- (a) Have the DIP switch position-3 set as
- (b) Output voltage can be trimmed by SVR.

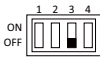

(2) By Output Voltage Programming

- (a) Have the DIP switch position-3 set as
- (b) The output voltage can be trimmed to 0~120% by applying EXTERNAL VOLTAGE between PV and GND on CN1.

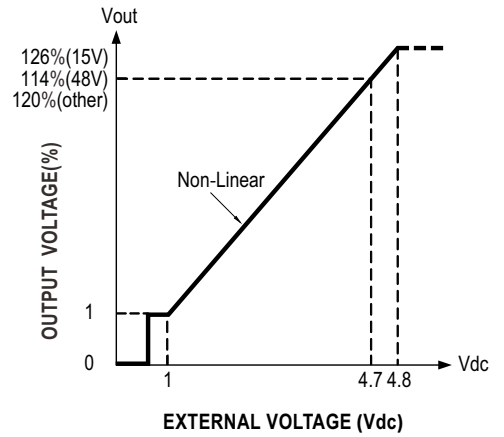
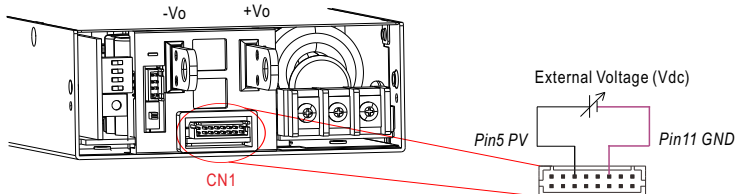
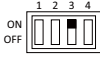

3. Output Current Programming (P.C)

(1) Default Overload Protection (OLP) value

- (a) Have the DIP switch position-2 set as
- (b) Output current is set default value.



(2) By Constant Current Level Programming

- (a) Have the DIP switch position-2 set as
- (b) The constant current level can be trimmed to 0~100% of the rated current by applying EXTERNAL VOLTAGE between PC and GND on CN1.

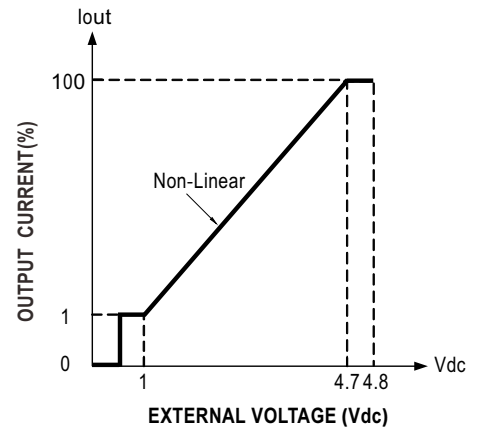
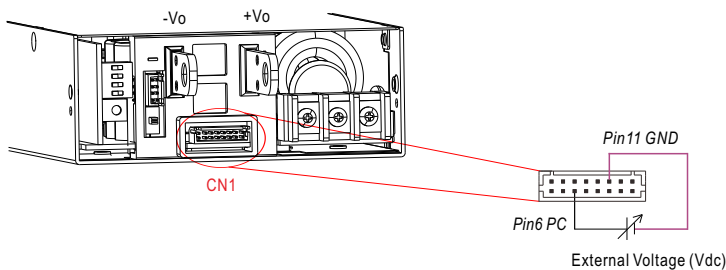
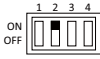

4. Remote Control

※ The power supply can be turned ON/OFF individually or along with other units by using the "Remote Control" function with external switch, photocoupler or relay.

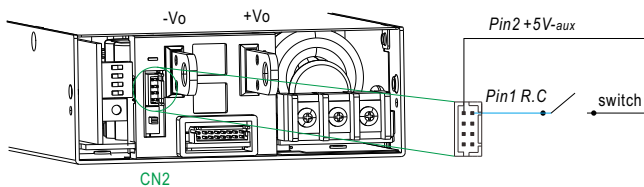

PSU Vo Status	Between +5V-aux(Pin 2) and R.C(Pin 1)
Power ON	Switch Short
Power OFF	Switch Open

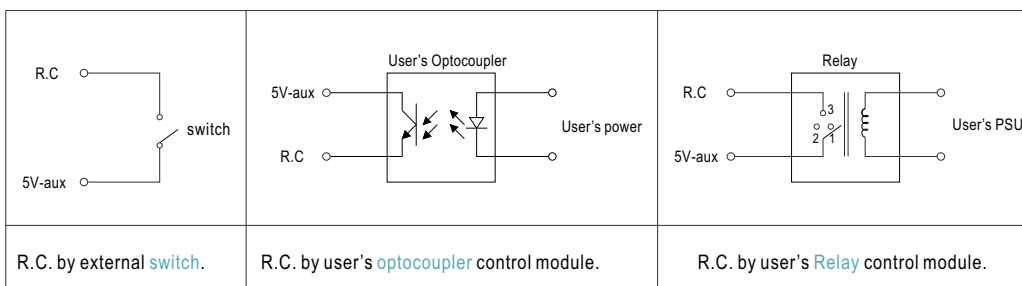

5. Remote Sense

※ The Remote Sense compensates voltage drop on the load wiring up to 0.5Vdc

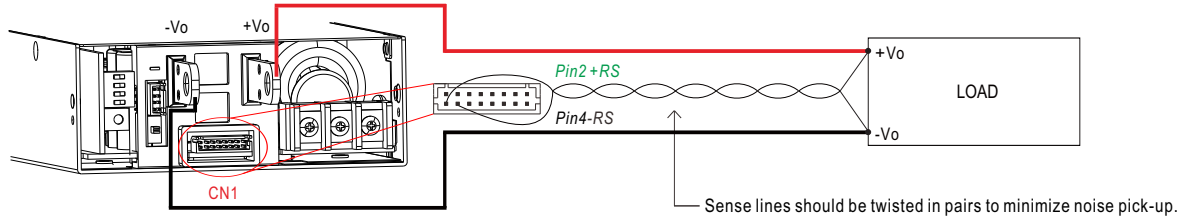

◎ The +RS signal should be connected to the positive terminal of the load whereas -RS signal to the negative terminal.

6. Local Sense

※ The +RS,-RS have to be connected to the +Vo(signal), -Vo(signal), respectively, as the following diagram, in order to get the correct output voltage if Remote Sense is not used.

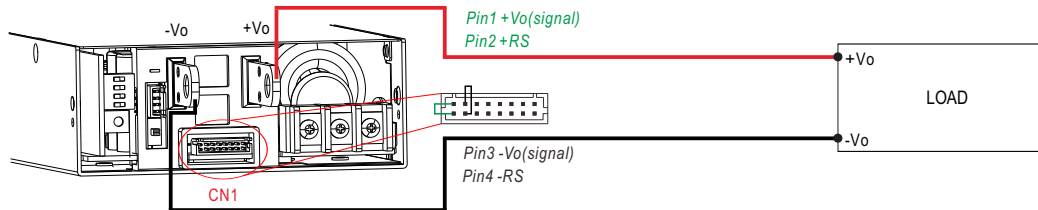

7. Parallel Function

NSP-2400 has the built-in active current sharing function and can be connected in parallel, up to 4 units, to provide higher output power as exhibited below :

- (1) The power supplies should be paralleled using short and large diameter wiring and then connected to the load.
- (2) Difference of output voltages among parallel units should be less than 0.2Vdc.
- (3) The total output current must not exceed the value determined by the following equation:

$$\text{Maximum output current at parallel operation} = (\text{Rated current per unit}) \times (\text{Number of unit}) \times 0.9$$
- (4) Under parallel operation, the minimum output load should be greater than 5% of total output load; otherwise, it is likely that only one unit operates whereas other units may enter standby mode or their LED status indicators may not turn on.
- (5) When the total output current is less than 5% of the total rated current, or say $(5\% \text{ of Rated current per unit}) \times (\text{Number of unit})$ the current shared among units may not be fully balanced.
- (6) For parallel operation, please contact MEAN WELL technical support if the output voltage is below 1.5V.
- (7) CN1/SW1 Function pin connection

Parallel	PSU1		PSU2		PSU3		PSU4	
	CN1	SW1 Pin4	CN1	SW1 Pin4	CN1	SW1 Pin4	CN1	SW1 Pin4
1 unit	X	ON	—	—	—	—	—	—
2 unit	✓	ON	✓	ON	—	—	—	—
3 unit	✓	ON	✓	—	✓	ON	—	—
4 unit	✓	ON	✓	—	✓	—	✓	ON

⊙ ✓ is CN1/DIP SW1 connected to plug pin, X is CN1/DIP SW1 not connected to plug pin.

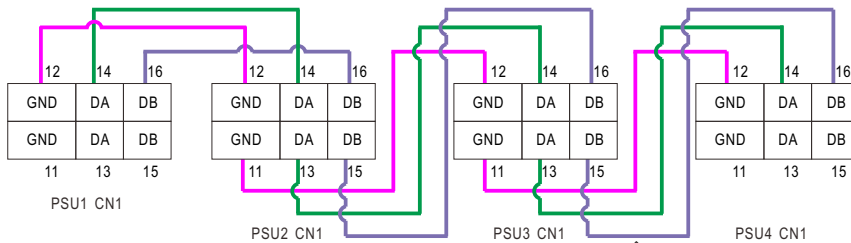
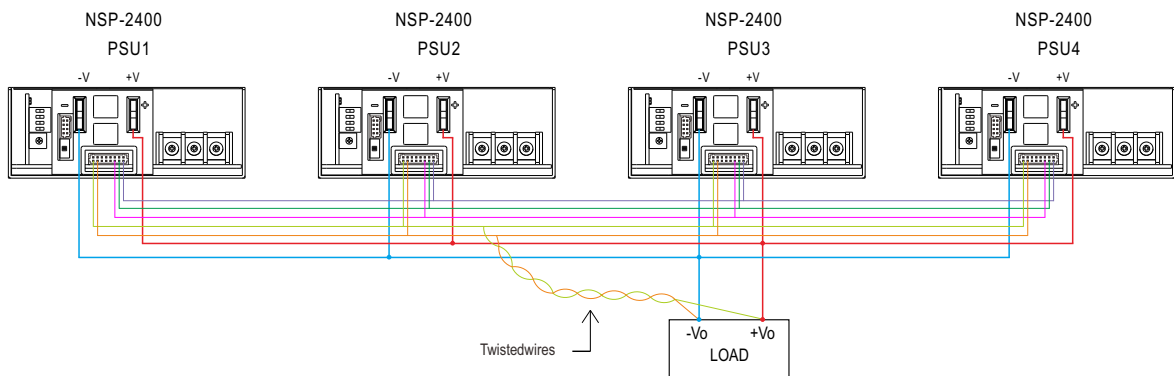

For longer CN1 cable lengths, twisted-pair wiring is recommended to minimize noise interference

◎ DA, DB and GND are connected mutually in parallel.

◎ DA, DB signal and parallel control function

(1) Non-parallel operation

(a) set the DIP switch of position-4 as

(b) By default, non-parallel operation.

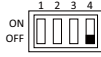

(2) Default parallel operation

(a) set the DIP switch of position-4 as

(b) PSUs are configured in parallel operation.

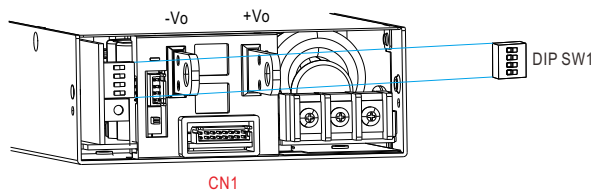
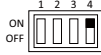

8. Overload Protection Mode

(1) Peak Power Mode

(a) Have the DIP switch position-1 as

(b) Limit current, shutdown after 5 or 2 seconds, recover after re-power on.

(c) Allow 1.33x or 2x peak power for 5 or 2 seconds.

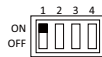

(2) Current Limiting Mode

(a) Have the DIP switch position-1 as

(b) Limit current.

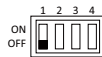

Note: With P.C function active, Peak Power Mode is disabled and the current limit defaults to the P.C setting

9. Support CANBus(Built-in) or MODBus Communication(By request)

※ Communication provides function such as control, setting and monitoring, Parameters include output power, input voltage, etc.

For more details, please refer to: <http://www.meanwell.com/manual.html>

Mechanical Specification

(Unit: mm , tolerance ±0.5mm)

Case No.294A

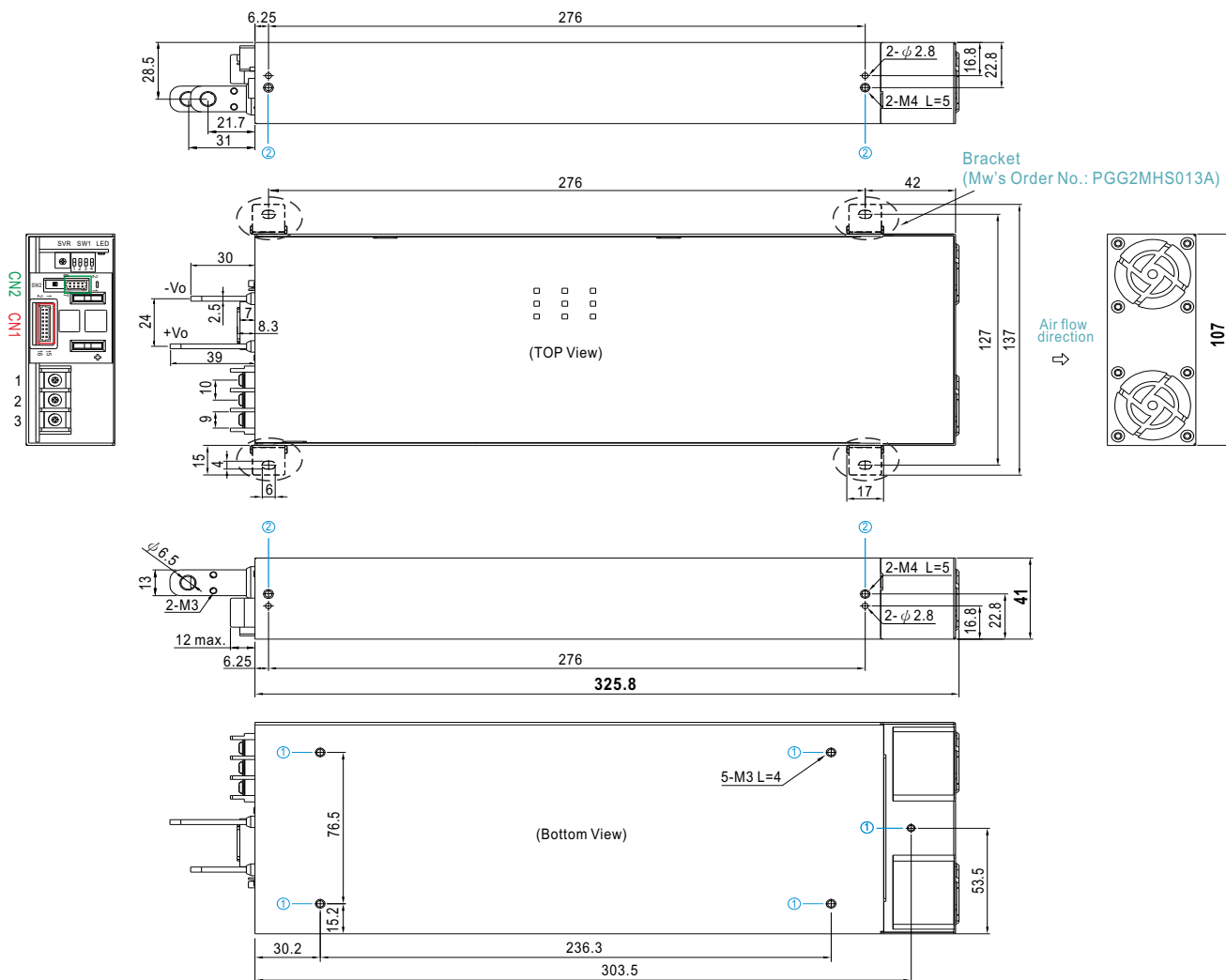

※ AC Input Terminal Pin No. Assignment

Pin No.	Assignment	Diagram	Screw Thread	Max. mounting torque
1	FG		M3.5	8Kgf-cm
2	AC/N			
3	AC/L			

※ Mounting Instruction

Hole No.	Recommended Screw Size	MAX. Penetration Depth L	Recommended mounting torque
①	M3	4mm	6~8Kgf-cm
②	M4	5mm	7~10Kgf-cm

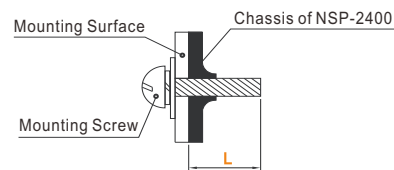

※ Control Pin No. Assignment (CN1) : HRS DF11-16DP-2DS or equivalent

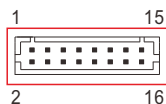

Mating Housing	HRS DF11-16DS or equivalent
Terminal	HRS DF11-16SC or equivalent

Pin No.	Function	Description
1	+Vo (Signal)	Positive output voltage signal. It is for local sense; it cannot be connected directly to the load.
2	+RS	Positive sensing for remote sense.
3	-Vo (Signal)	Negative output voltage signal. It is for local sense and certain function reference; it cannot be connected directly to the load.
4	-RS	Negative sensing for remote sense.
5	PV	Connection for output voltage programming. (Note.1)
6	PC	Connection for constant current level programming. (Note.1)
7,8,9,10	A0,A1,A2,A3	Interface address lines. (Note.2)
11,12	GND	These pins connect to the negative terminal (-Vo).
13, 14	DA	Differential digital signal for parallel control.
15, 16	DB	Differential digital signal for parallel control.

Note1: Non-isolated signal, referenced to (GND).

Note2: Interface address setting, please refer to the user manual for more details.

※ Control Pin No. Assignment(CN2) : HRS DF11-08DP-2DS or equivalent

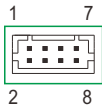

Mating Housing	HRS DF11-08DS or equivalent
Terminal	HRS DF11-08SC or equivalent

Pin No.	Function	Description
1	R.C	The unit can turn the output ON/OFF by electrical signal or dry contact between R.C and +5V-aux. (Note) Short (4.5 ~ 5.5Vdc) : Power ON ; Open (-0.5 ~ 0.5Vdc) : Power OFF ; The maximum input voltage is 5.5Vdc.
2	+5V-AUX	Auxiliary voltage output, 4.25~5.75Vdc, referenced to GND-aux. The maximum load current is 0.2A. This output has the built-in "Oring diodes" and is not controlled by "R.C"
3	DC-OK	High (3.5 ~ 5.5Vdc) : When the Vout $\leq 77\% \pm 5\%$. Low (-0.5 ~ 0.5Vdc) : When Vout $\geq 80\% \pm 5\%$. The maximum sourcing current is 10mA and only for output. (Note)
4,6	GND-AUX	Auxiliary voltage output GND. The signal return is isolated from the output terminals (+Vo & -Vo).
5	+12V-AUX	Auxiliary voltage output, 10.2~13.8Vdc, referenced to GND-aux. The maximum load current is 0.8A. This output has the built-in "Oring diodes" and is not controlled by "R.C".
7	D+	For MODBus model: Data line used in MODBus interface. (Note)
	CANH	For CANBus model: Data line used in CANBus interface. (Note)
8	D-	For MODBus model: Data line used in MODBus interface. (Note)
	CANL	For CANBus model: Data line used in CANBus interface. (Note)

Note: Isolated signal, referenced to GND-AUX.

※ DIP Switch Position Assignment(DIP-SW1): Please refer to the User Manual.

Pin No.	Assignment	Diagram
1	Overload(OLP) type select	
2	Output Current Programming (PC)	
3	Output Voltage Programming (PV)	
4	DA,DB Signal and paralld control function	

DIP-SW PIN1:OL_SD
DIP-SW PIN2:PC
DIP-SW PIN3:PV
DIP-SW PIN4:PRL

※ LED Status Indicators

Description	Output of alarm
Normal operation	Green : Steadily lit
Remote off	Red : Steadily lit
Internal over-temperature	Orange : 1 Blink/Pause
Overload / Short	Red : 1 Blink/Pause
Over voltage	Red : 2 Blink/Pause
Over temperature	Red : 3 Blink/Pause
Fan fail	Red : 4 Blink/Pause
AC under voltage	Red : 5 Blink/Pause
Others (Note)	Red : 6 Blink/Pause

Note: 1. Others include hardware fault etc

2. In Current Limiting mode, OLP operate in constant current limiting, with the indicator steadily lit green.

※ Control Pin Assignment SW2



Function	Description
ON	Termination resistors(120Ω). For CANBus/MODBus communication.
OFF	No need to communicate.

■ Accessory List

No.	Item	Quantity
1	Remote Sense(CN1) mating wire along with NSP-2400 (standard accessory)	1pcs/per model
2	Remote Control(CN2) mating wire along with NSP-2400 (standard accessory)	1pcs/per model
3	Bracket Mw's Order No.: PGG2MHS013A (Optional accessories can be purchased separately)	4pcs/per model (Please refer to Installation Diagram)
4	Terminal cover MW'S Order NO. :PEE4TBC-03-DG (Optional accessories can be purchased separately)	1pcs/per model

■ Installation Diagram

